

Product Specification of LED Emergency Light

Model No. : EXL-670L series

June 28, 2020

Product Photo



Product Dimension

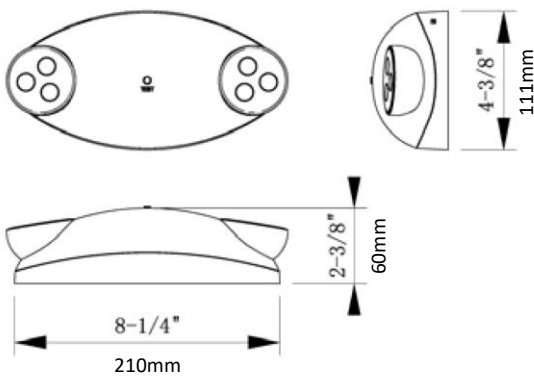

Order Guide

Family	Input Voltage	Lumen Output	Test Facility	Housing Color
EXL-670L	Blank: 120-277V	Blank: Standard model	Manual test	White
	D: 120/277V	-HO: High lumen output model		

Product Feature

Housing

- Injection-molded thermoplastic PVC housing.
- Plastic enclosure with 5VA flame retardant.
- Compact and decorative design.
- Two fully adjustable glare-free shape light heads for emergency light.

Electrical

- 120/277VAC 60Hz Dual voltage operation.
- 120-277VAC universal input voltage operation.
- Brownout protection for universal voltage input model.
- Over load/short circuit protection.
- Test switch and charge rate indicator.
- 3.6V Long-life, maintenance-free, rechargeable Ni-Cad battery.
- 24 hours recharge after 90min. discharge duration.

Illumination

- SMD 2835 LED, CCT 5700K, L70 50,000 hours.
- Standard model deliver 240lm at discharge period.
- High lumen model deliver 400lm at discharge.
- Multiple lens and single lens optional.

Mounting

- Suitable for wall mount and ceiling mount.
- Top and side knockout for conduit applications.

Note

- Lifetime of battery has 500 recycle times.
- Suitable for use in 10°C-40°C ambient temperature, suitable for damp location.
- UL listed according standard UL924.
- Meets or exceed all requirement in NFPA 70, NFPA 101 life safety code.

Model List and Parameters

No.	Model	Test facility	Battery	Recharge time	Emergency time	Input			Output	
						Voltage	Hz	Power consumption (maintenance mode)	Lamp head	Luminous flux
1	EXL-670LD	Manual test	Ni-Cad 3.6V 1000mAh	24 hours	90 minutes	120/277V	50/60Hz	0.8W	1W*2pcs	240lm
2	EXL-670LD-HO	Manual test	Ni-Cad 3.6V 1000mAh*2pcs	24 hours	90 minutes	120/277V	50/60Hz	1.0W	1.8W*2pcs	400lm
3	EXL-670L	Manual test	Ni-Cad 3.6V 1000mAh	24 hours	90 minutes	120-277V	50/60Hz	1.5W	1W*2pcs	240lm
4	EXL-670L-HO	Manual test	Ni-Cad 3.6V 1000mAh*2pcs	24 hours	90 minutes	120-277V	50/60Hz	2.5W	1.8W*2pcs	400lm



LITE
ElectronicsTM

EXL-670L Series LED Emergency Light Specification

Photometric

Wall mounting, mounting height 7.5ft (2.2m) / 10ft (3m)

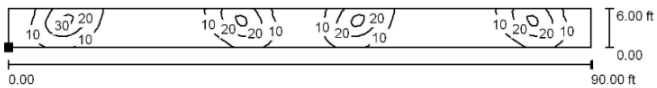
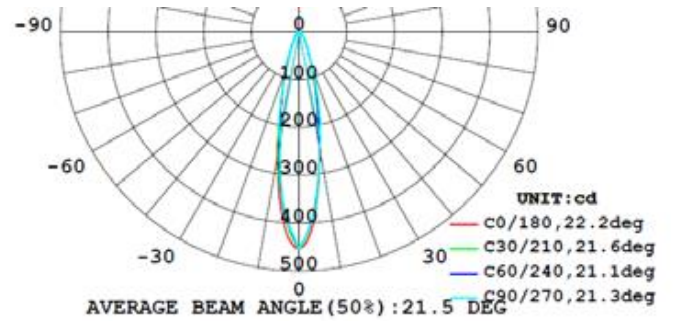
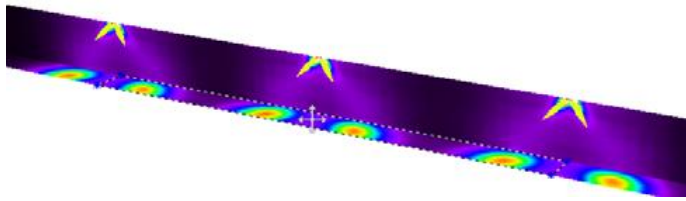

Position of surface in room:
 Marked point: (30.000 ft, 0.000 ft, 0.000 ft)

Grid: 128 x 32 Points

E_{av} [lx] E_{min} [lx] E_{max} [lx] $u0$
 11 1.99 32 0.186

No.	Model	Center to Center Spacing (7.5ft)	Center to Center Spacing (10ft)	Lumen output
1	EXL-670L	25 feet (7.6m)	24 feet (7.3m)	240lm
2	EXL-670L-HO	45 feet (13.7m)	43 feet (13.1m)	400lm

Ceiling mounting, mounting height 10ft (3m)

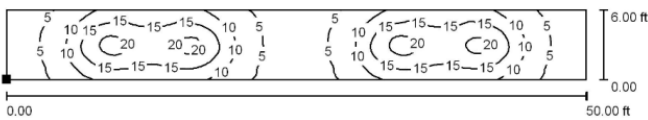
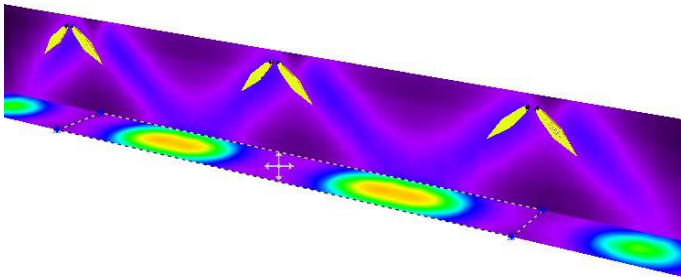

Position of surface in room:
 Marked point: (25.000 ft, 0.000 ft, 0.000 ft)

Grid: 128 x 32 Points

E_{av} [lx] E_{min} [lx] E_{max} [lx] $u0$
 11 3.19 21 0.299

No.	Model	Center to Center Spacing	Lumen output
1	EXL-670L	24 feet (7.3m)	240lm
2	EXL-670L-HO	43 feet (13.1m)	400lm

Packaging

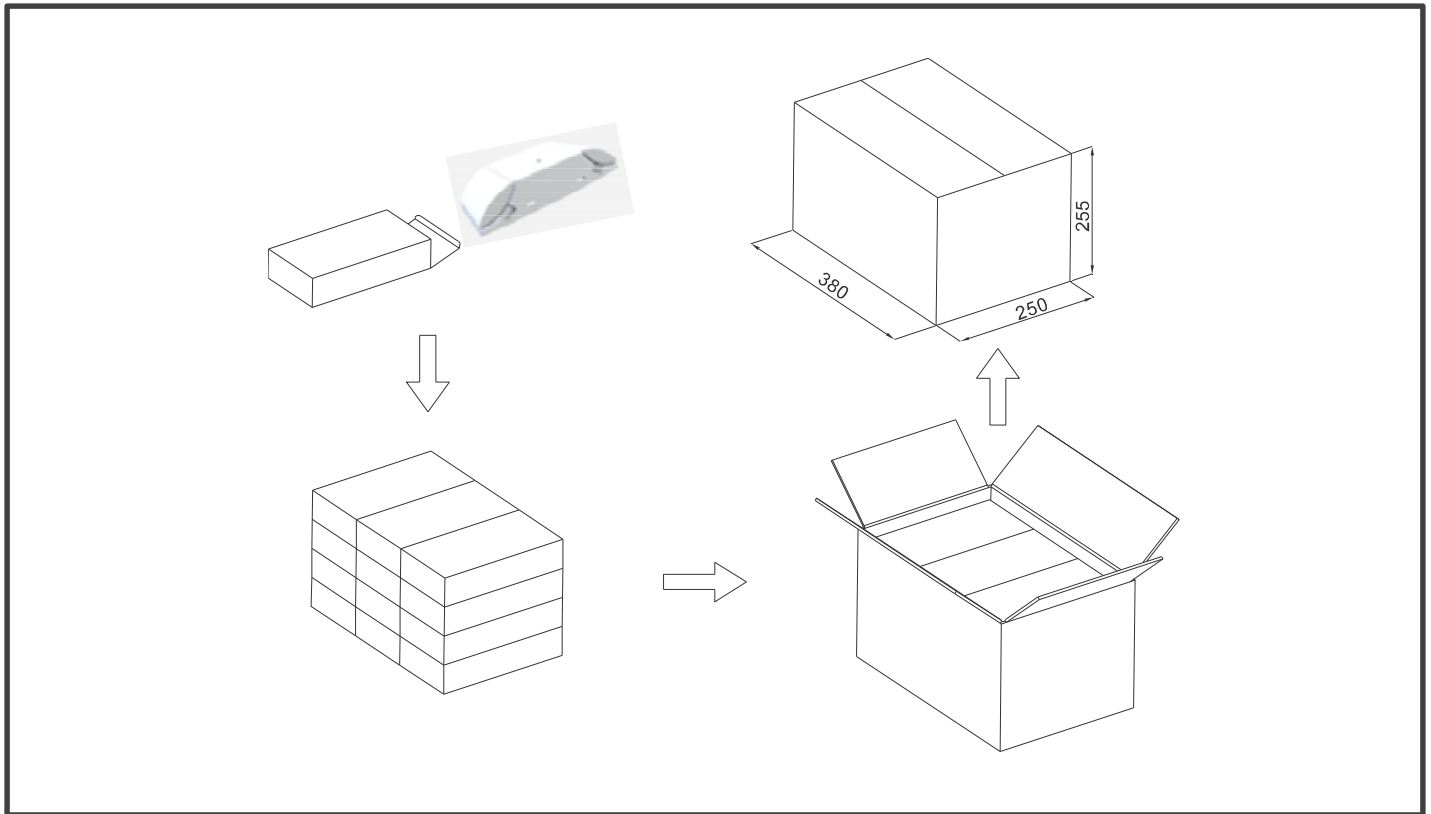

No.	Model	Packing Qty	N.W/G.W	Size(L*W*H)
1	EXL-670L	12pcs	3.9kg / 6.0kg	380(L)*250(W)*255(H)mm
2	EXL-670L-HO	12pcs	3.9kg / 6.0kg	380(L)*250(W)*255(H)mm